

SI-3000J Series

5-Terminal, Multi-Function, Full-Mold, Low Dropout Voltage Dropper Type

■Features

- Compact full-mold package (equivalent to TO220)
- Output current: 2.0A
- Low dropout voltage: $V_{DIF} \leq 1V$ (at $I_o = 2.0A$)
- Variable output voltage (rise only) May be used for remote sensing
- Output ON/OFF control terminal is compatible with LS-TTL. (It may be directly driven by LS-TTL or standard CMOS logic.)
- Built-in foldback overcurrent, overvoltage, thermal protection circuits

■Applications

- For stabilization of the secondary stage of switching power supplies
- Electronic equipment



■Absolute Maximum Ratings

($T_a = 25^\circ C$)

Parameter	Symbol	Ratings			Unit
		SI-3050J	SI-3090J	SI-3120J/3150J	
DC Input Voltage	V_{IN}	25	30	35	V
Voltage of Output Control Terminal	V_c	V_{IN}			V
DC Output Current	I_o	2.0^{*1}			A
Power Dissipation	P_{D1}	20(With infinite heatsink)			W
	P_{D2}	1.5(Without heatsink, stand-alone operation)			W
Junction Temperature	T_j	-40 to +125			$^\circ C$
Ambient Operating Temperature	T_{op}	-30 to +100			$^\circ C$
Storage Temperature	T_{stg}	-40 to +125			$^\circ C$
Thermal Resistance (junction to case)	$R_{th(j-c)}$	5.0			$^\circ C/W$
Thermal Resistance (junction to ambient air)	$R_{th(j-a)}$	66.7(Without heatsink, stand-alone operation)			$^\circ C/W$

■Electrical Characteristics

(Ta=25°C unless otherwise specified)

Parameter	Symbol	Ratings												Unit	
		SI-3050J			SI-3090J			SI-3120J			SI-3150J				
		min.	typ.	max.	min.	typ.	max.	min.	typ.	max.	min.	typ.	max.		
Input Voltage	V _{IN}	6 ²		15 ¹	10 ²		25 ¹	13 ²		27 ¹	16 ²		27 ¹	V	
Output Voltage	V _O	4.90	5.00	5.10	8.82	9.00	9.18	11.76	12.00	12.24	14.70	15.00	15.30	V	
	Conditions	V _{IN} =8V, I _O =1.0A			V _{IN} =12V, I _O =1.0A			V _{IN} =15V, I _O =1.0A			V _{IN} =18V, I _O =1.0A				
Dropout Voltage	V _{DIF}			0.5			0.5			0.5			0.5	V	
	Conditions	I _O ≤1.5A													
	Conditions			1.0			1.0			1.0			1.0		
Line Regulation	ΔV _{OLINE}		10	30		18	48		24	64		30	90	mV	
	Conditions	V _{IN} =6 to 15V, I _O =1.0A			V _{IN} =10 to 20V, I _O =1.0A			V _{IN} =13 to 25V, I _O =1.0A			V _{IN} =16 to 25V, I _O =1.0A				
Load Regulation	ΔV _{OLOAD}		40	100		70	180		93	240		120	300	mV	
	Conditions	V _{IN} =8V, I _O =0 to 2.0A			V _{IN} =12V, I _O =0 to 2.0A			V _{IN} =15V, I _O =0 to 2.0A			V _{IN} =18V, I _O =0 to 2.0A				
Temperature Coefficient of Output Voltage	ΔV _O /ΔT _a		±0.5			±1.0			±1.5			±1.5		mV/°C	
	Conditions	V _{IN} =8V, I _O =5mA, T _J =0 to 100°C			V _{IN} =12V, I _O =5mA, T _J =0 to 100°C			V _{IN} =15V, I _O =5mA, T _J =0 to 100°C			V _{IN} =18V, I _O =5mA, T _J =0 to 100°C				
Ripple Rejection	R _{REJ}		54			54			54			54		dB	
	Conditions	V _{IN} =8V, f=100 to 120Hz			V _{IN} =12V, f=100 to 120Hz			V _{IN} =15V, f=100 to 120Hz			V _{IN} =18V, f=100 to 120Hz				
Quiescent Circuit Current	I _q		3	10		3	10		3	10		3	10	mA	
	Conditions	V _{IN} =8V, I _O =0A			V _{IN} =12V, I _O =0A			V _{IN} =15V, I _O =0A			V _{IN} =18V, I _O =0A				
	I _q (off)		0.5	1.0		0.5	1.0		0.5	1.0		0.5	1.0	mA	
Overcurrent Protection Starting Current ^{*3,5}	I _{S1}	2.1			2.1			2.1			2.1			A	
	Conditions	V _{IN} =8V			V _{IN} =12V			V _{IN} =15V			V _{IN} =18V				
V _C Terminal ^{*4}	Control Voltage (Output ON)	V _C IH	2.0			2.0			2.0			2.0		V	
	Control Voltage (Output OFF)	V _C IL			0.8			0.8			0.8		0.8		
	Control Current (Output ON)	I _C IH			20			20			20			20	μA
		Conditions	V _C =2.7V												
	Control Current (Output OFF)	I _C IL			-0.3			-0.3			-0.3			-0.3	mA
Conditions		V _C =0.4V													

*1: V_{IN(max)} and I_{O(max)} are restricted by the relation P_{D(max)}=(V_{IN}-V_O)•I_O=20(W).

*2: Refer to the dropout voltage.(Refer to Setting DC Input Voltage on page 7.)

*3: I_{S1} is specified at -5(%) drop point of output voltage V_O on the condition that V_{IN}=V_O+3V, I_O=0.5A.

*4: Output is ON even when output control terminal V_C is open. Each input level is equivalent to LS-TTL. Therefore, it may be directly driven by an LS-TTL circuit.

*5: A foldback type overcurrent protection circuit is built into the I_C regulator. Therefore, avoid using it for the following applications as it may cause starting errors:

- (1) Constant current load (2) Plus/minus power (3) Series power (4) V_O adjustment by raising ground voltage

■Outline Drawing

(unit:mm)

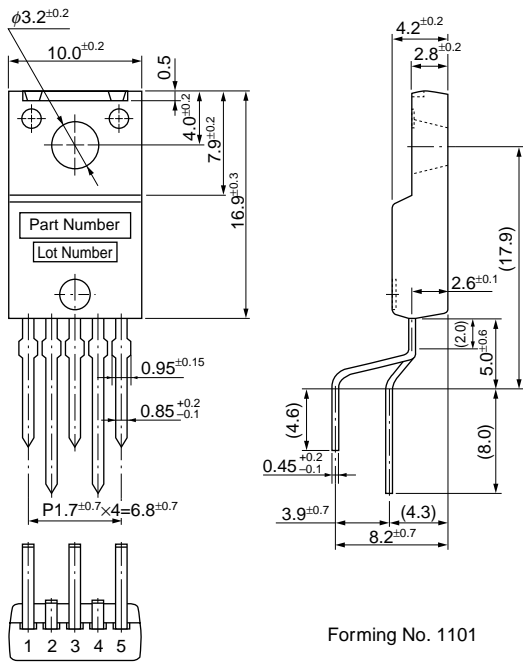

Plastic Mold Package Type
 Flammability: UL94V-0
 Weight: Approx. 2.3g

- ① GND
- ② Vc
- ③ Vo
- ④ Vos
- ⑤ VIN

■Block Diagram

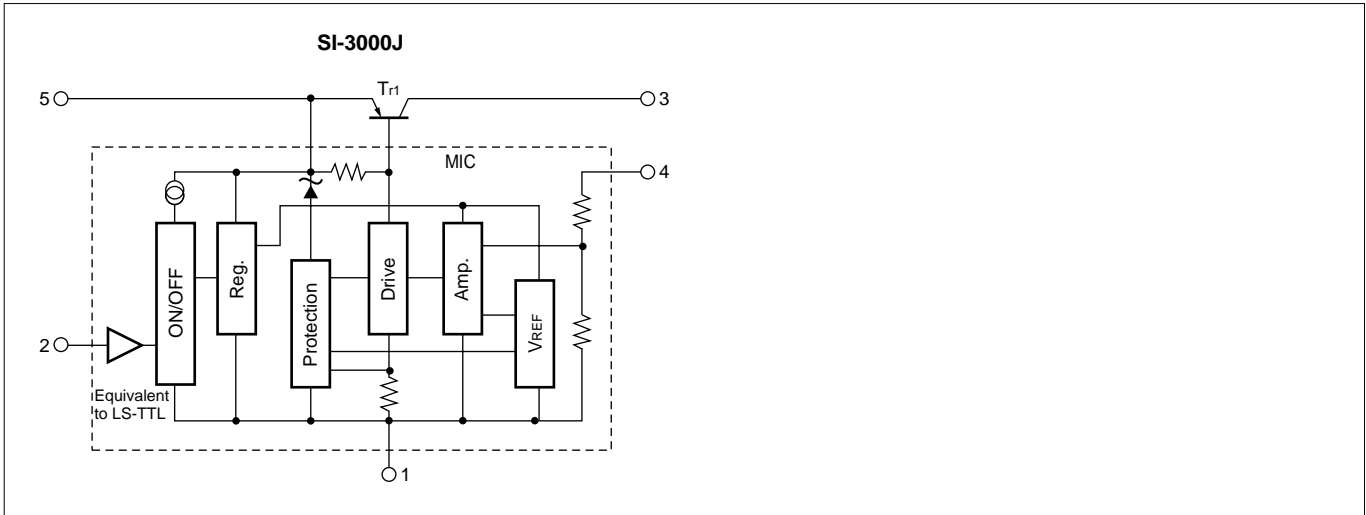

■Standard External Circuit

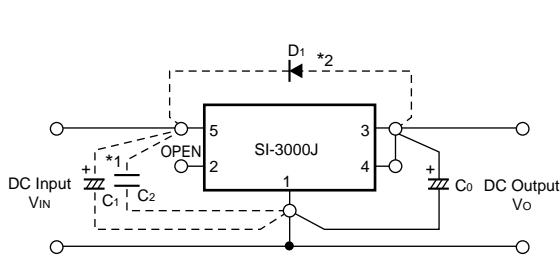

- C₀ : Output capacitor (47 to 100μF)
- *1 C₁ } Oscillation prevention capacitor (C₁: Approx. 47μF,
- C₂ } C₂: 0.33μF)
- These capacitors are required if the input line is inductive and in the case of long wiring. Tantalum capacitors are recommended for C₁ and C₀, particularly at low temperatures.
- *2 D₁ : Protection diode
- This diode is required for protection against reverse biasing of the input and output. Sanken EU2Z is recommended.

■T_a-P_D Characteristics

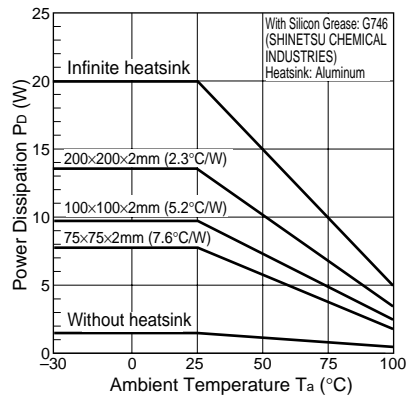

$$P_D = I_o \cdot [V_{IN(\text{mean})} - V_o]$$

External Variable Output Voltage Circuit

1. Variable output voltage with a single external resistor

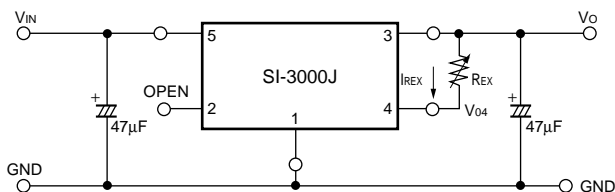

The output voltage may be increased by inserting resistor R_{EX} between terminals No.4 (sensing terminal) and No.3 (output terminal). The current I_{REX} flowing into terminal No.4 is 1mA (typ.), therefore the adjusted output voltage V_{OUT} is:

$$V_O = V_{04} + I_{REX} \cdot R_{EX} \quad *V_{04}: \text{output voltage of SI-3000J series}$$

However, the built-in resistor (between terminals No. 4 and No.1) is a semiconductor resistor, which has approximately thermal characteristics of +0.2%/°C.

It is important to keep the thermal characteristics in mind when adjusting the output voltage.

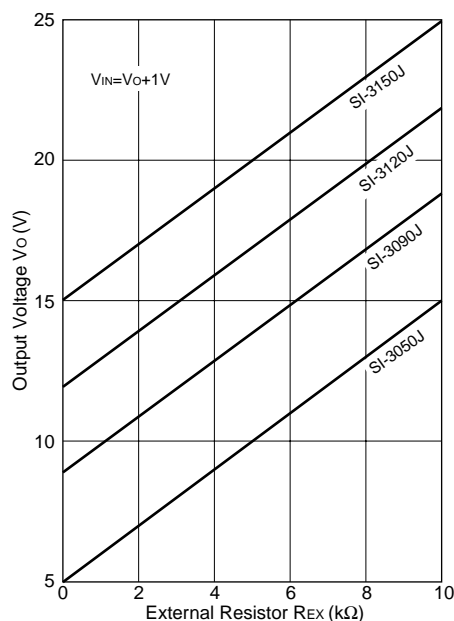

2. Variable output voltage with two external resistors

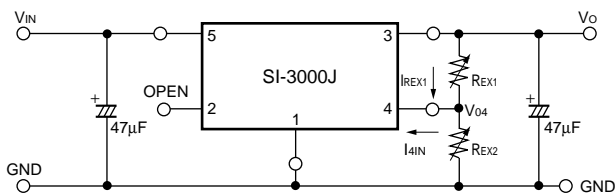

The output voltage may be increased by inserting resistors R_{EX1} between terminals No.4 (sensing terminal) and No.3 (output terminal) and R_{EX2} between terminals No.4 and No.1 (ground terminal).

The current I_{4IN} flowing into terminal No.4 is 1mA (typ.) so the thermal characteristics may be improved compared to the method shown in 1 by setting the external current I_{REX1} at approximately 5 times the value of I_{4IN} (stability coefficient $S=5$).

The adjusted output voltage V_{OUT} in this case is:

$$\begin{cases} V_O = V_{04} + R_{EX1} \cdot I_{REX1} \\ I_{REX1} = S \cdot I_{4IN} \end{cases}$$

The value of the external resistors may be obtained as follows:

$$R_{EX1} = \frac{V_O - V_{04}}{S \cdot I_{4IN}}, \quad R_{EX2} = \frac{V_{04}}{(S-1) \cdot I_{4IN}}$$

* V_{04} : Output voltage of SI-3000J series

S: Stability coefficient of I_{4IN} (may be set to any value)

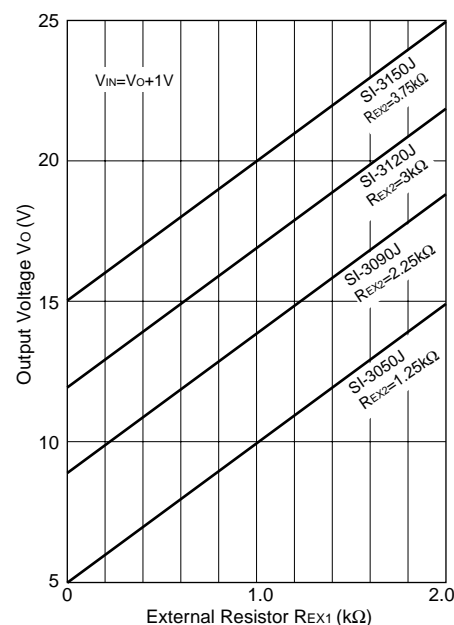

Note: In the SI-3000J series, the output voltage increase can be adjusted as mentioned above. However, when the rise is set to approximately 10V compared to output voltage V_{04} , the necessary output current may not be obtained due to the S.O.A. protection circuit in the SI-3000J series.

■Typical Characteristics

($T_a=25^{\circ}\text{C}$)

Io vs. VdIF Characteristics

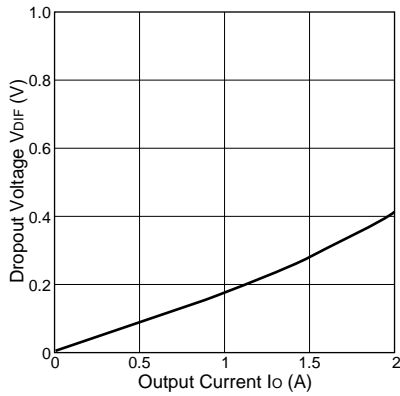

Temperature Coefficient of Output Voltage(SI-3050J)

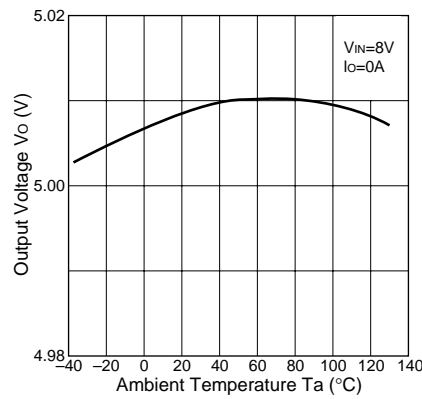

Circuit Current(SI-3050J)

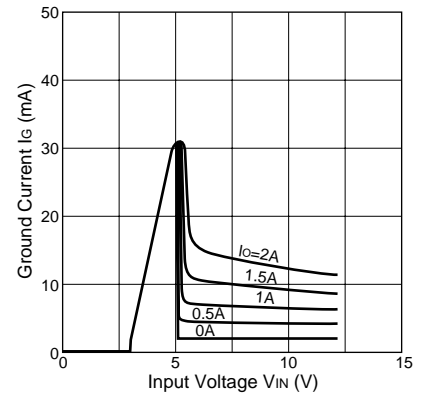

Quiescent Circuit Current(SI-3050J)

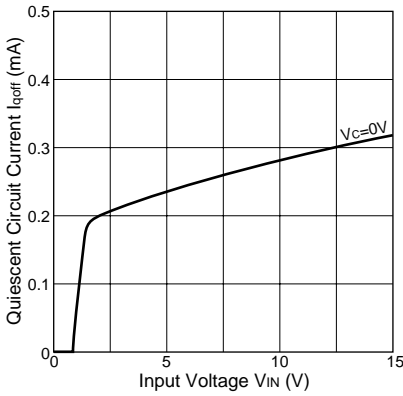

Rise Characteristics(SI-3050J)

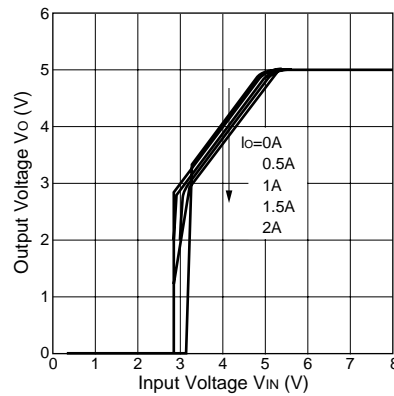

Rise Characteristics(SI-3120J)

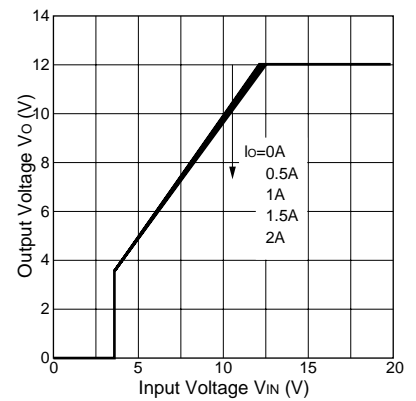

Overcurrent Protection Characteristics(SI-3050J)

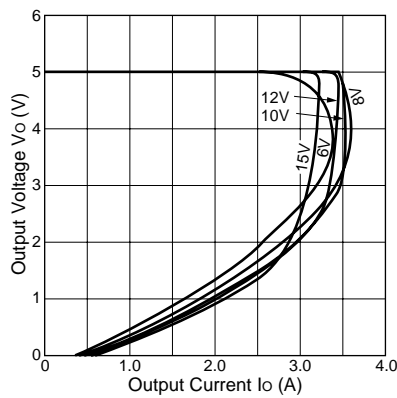

Overcurrent Protection Characteristics(SI-3120J)

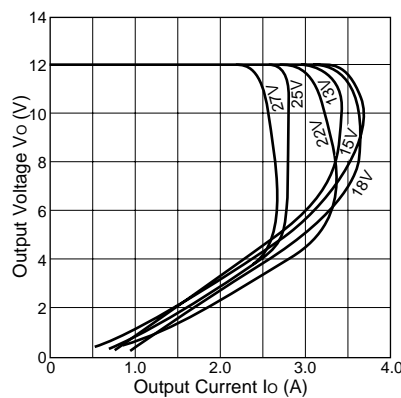

ON/OFF Control Characteristics(SI-3050J)

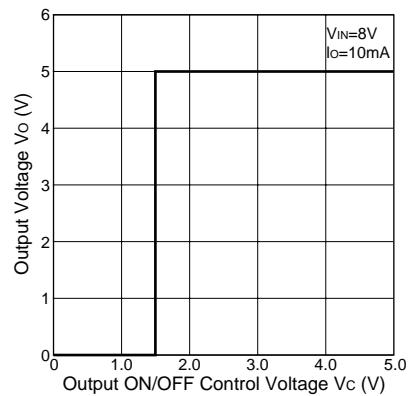

Thermal Protection(CharacteristicsSI-3050J)

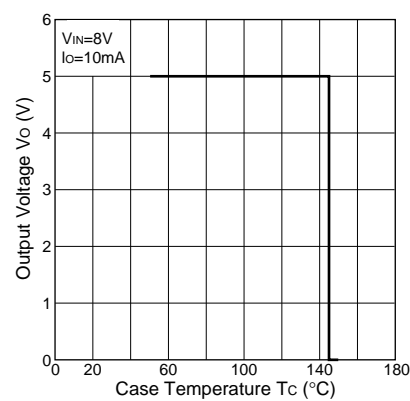

Note on Thermal Protection:

The thermal protection circuit is intended for protection against heat during instantaneous short-circuiting. Its operation is not guaranteed for short-circuiting over extended periods of time.